

P 149 km 8,392 52 – MOST Š. 4,1m
(foto návodní strana)
M 1:100/100

$Q_{100} = 66,3 \text{ m}^3 \cdot \text{s}^{-1}, 219,63 \text{ m n. m.}$
 $Q_{20} = 43,3 \text{ m}^3 \cdot \text{s}^{-1}, 219,23 \text{ m n. m.}$
 $Q_5 = 27,3 \text{ m}^3 \cdot \text{s}^{-1}, 218,73 \text{ m n. m.}$

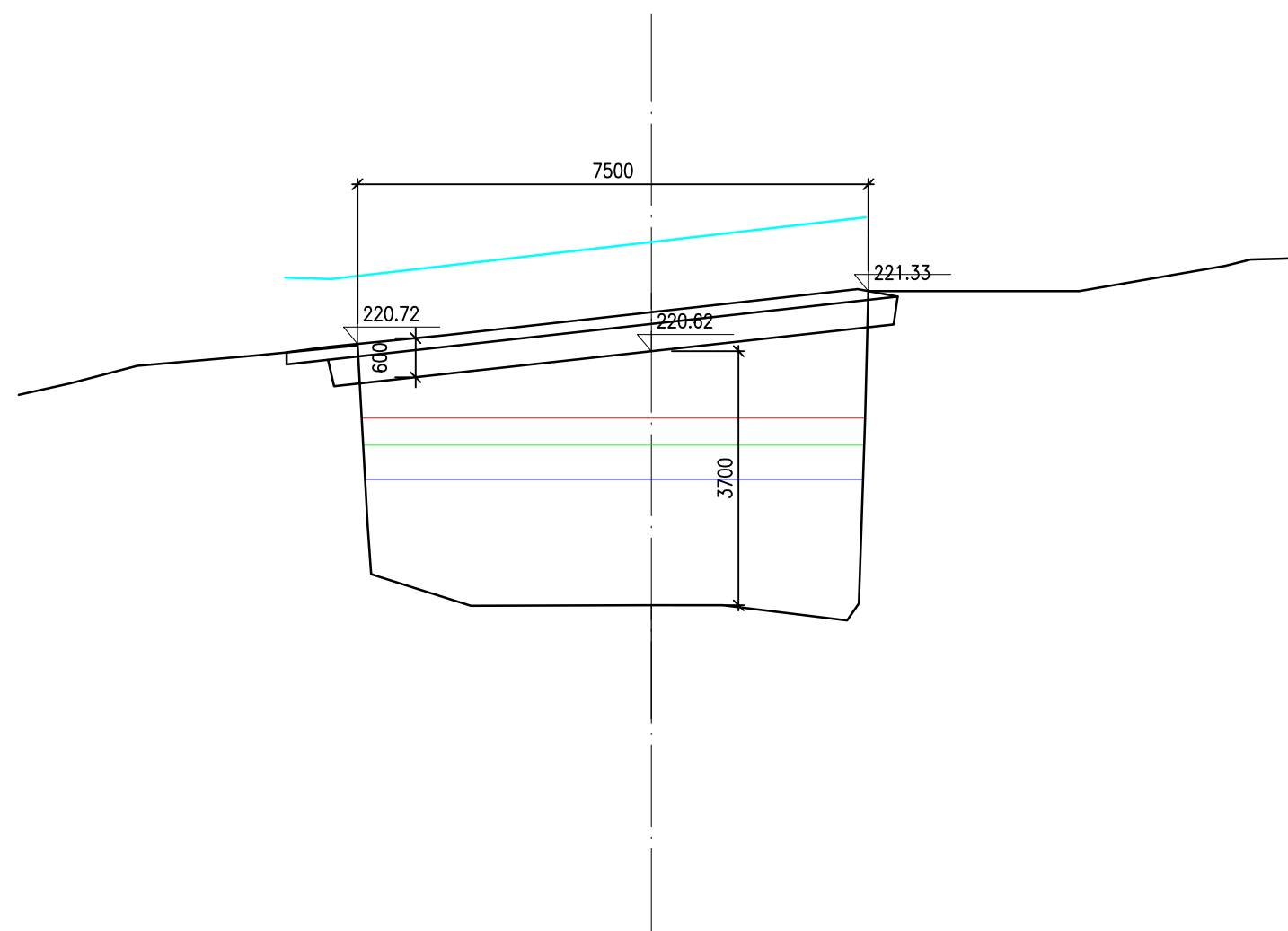

S.R. – 212,00