

P 228 km 18,321 87 – DŘEVĚNÝ MOSTEK Š. 1,1m
(foto návodní strana)
M 1:100/100

$Q_{100} = 41,3 \text{ m}^3 \cdot \text{s}^{-1}, 259,74 \text{ m n. m.}$
 $Q_{20} = 27,0 \text{ m}^3 \cdot \text{s}^{-1}, 259,61 \text{ m n. m.}$
 $Q_5 = 17,0 \text{ m}^3 \cdot \text{s}^{-1}, 259,49 \text{ m n. m.}$

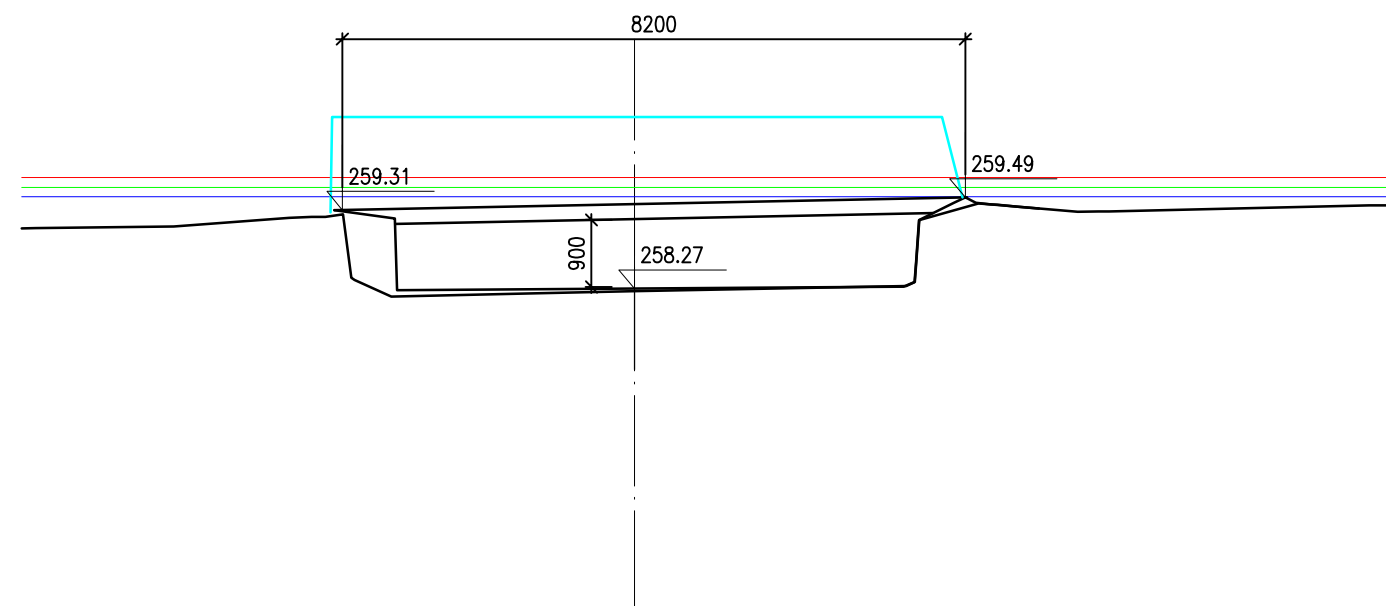

S.R. – 254,00