

P 97 km 4,444 80

Q<sub>10</sub> = 69,9 m<sup>3</sup>/s, 204,92 m n.m.  
Q<sub>5</sub> = 45,3 m<sup>3</sup>/s, 204,98 m n.m.  
Q<sub>1</sub> = 28,2 m<sup>3</sup>/s, 204,98 m n.m.

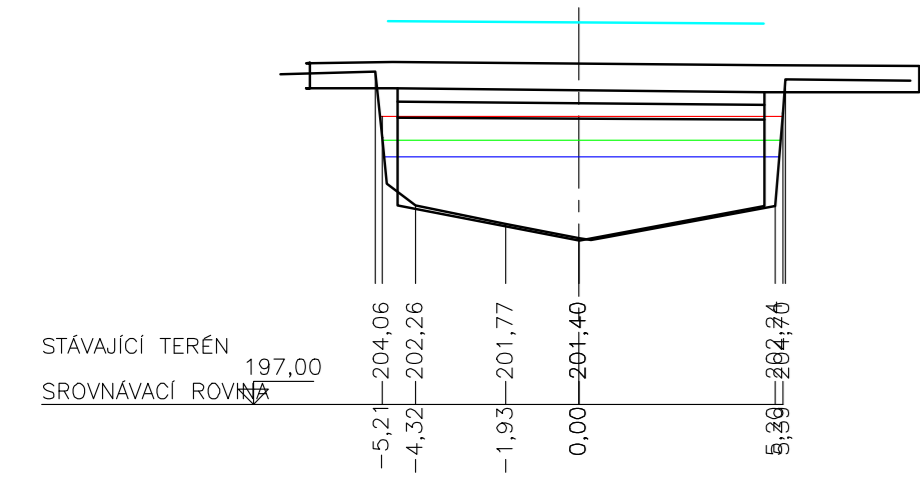

P 104 km 4,855 73

Q<sub>10</sub> = 69,9 m<sup>3</sup>/s, 204,92 m n.m.  
Q<sub>5</sub> = 45,3 m<sup>3</sup>/s, 204,98 m n.m.  
Q<sub>1</sub> = 28,2 m<sup>3</sup>/s, 204,98 m n.m.

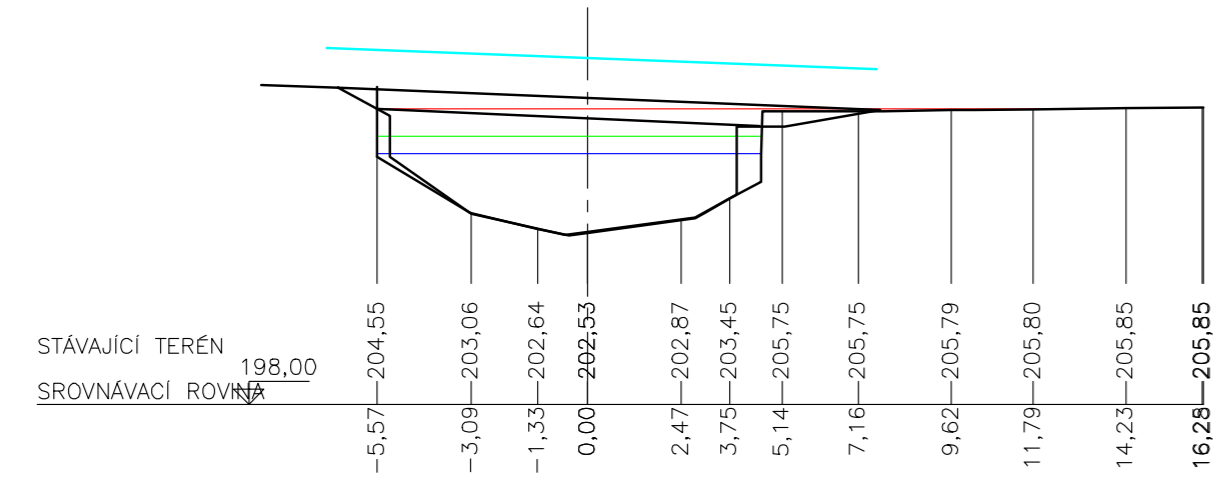

P 112 km 5,152 47

Q<sub>10</sub> = 69,9 m<sup>3</sup>/s, 204,92 m n.m.  
Q<sub>5</sub> = 45,3 m<sup>3</sup>/s, 204,98 m n.m.  
Q<sub>1</sub> = 28,2 m<sup>3</sup>/s, 204,98 m n.m.

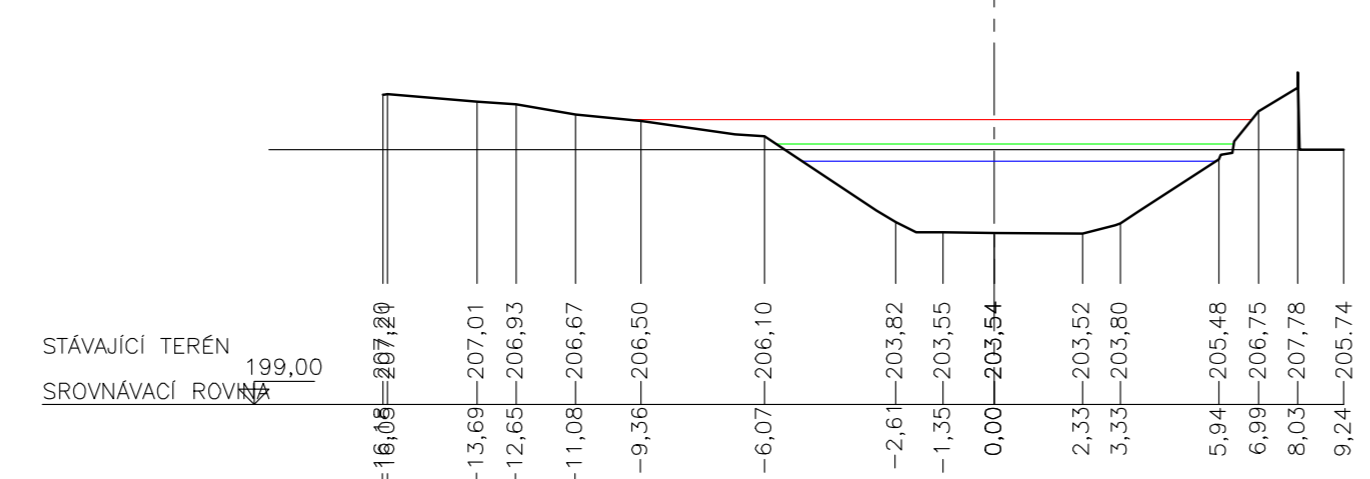

P 113 km 5,175 00

Q<sub>10</sub> = 69,9 m<sup>3</sup>/s, 204,92 m n.m.  
Q<sub>5</sub> = 45,3 m<sup>3</sup>/s, 204,98 m n.m.  
Q<sub>1</sub> = 28,2 m<sup>3</sup>/s, 204,98 m n.m.

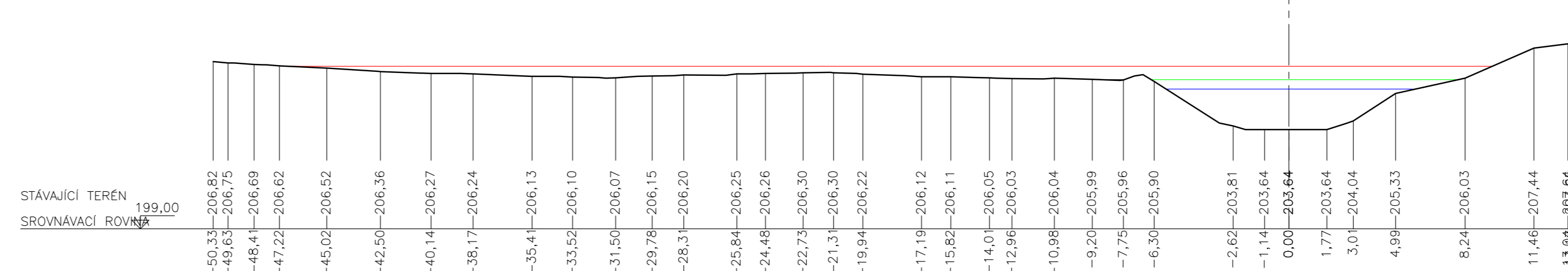

P 98 km 4,472 00

Q<sub>10</sub> = 69,9 m<sup>3</sup>/s, 204,92 m n.m.  
Q<sub>5</sub> = 45,3 m<sup>3</sup>/s, 204,98 m n.m.  
Q<sub>1</sub> = 28,2 m<sup>3</sup>/s, 204,98 m n.m.

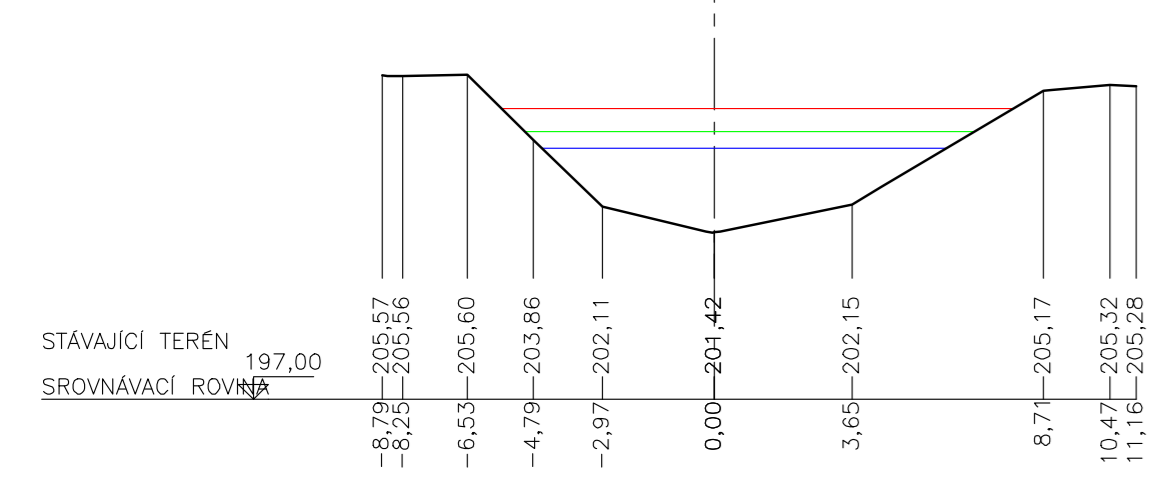

P 105 km 4,902 06

Q<sub>10</sub> = 69,9 m<sup>3</sup>/s, 204,92 m n.m.  
Q<sub>5</sub> = 45,3 m<sup>3</sup>/s, 204,98 m n.m.  
Q<sub>1</sub> = 28,2 m<sup>3</sup>/s, 204,98 m n.m.

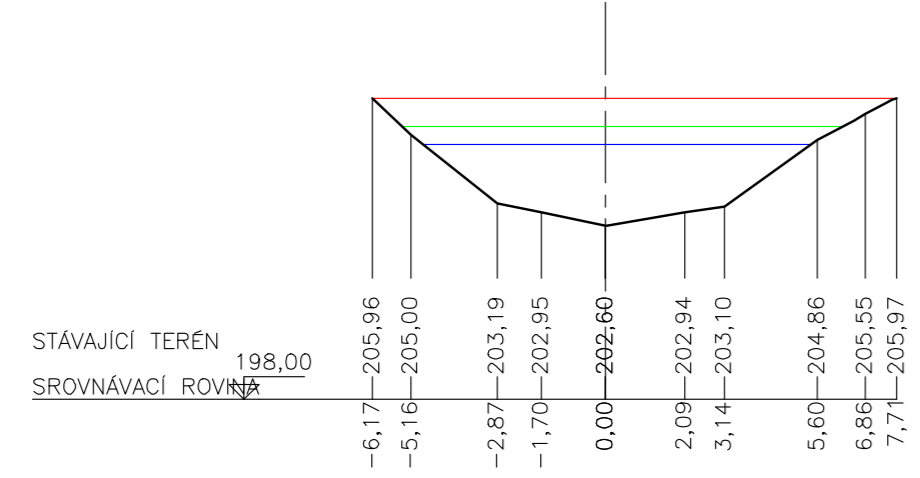

P 114 km 5,275 50

Q<sub>10</sub> = 69,9 m<sup>3</sup>/s, 204,92 m n.m.  
Q<sub>5</sub> = 45,3 m<sup>3</sup>/s, 204,98 m n.m.  
Q<sub>1</sub> = 28,2 m<sup>3</sup>/s, 204,98 m n.m.

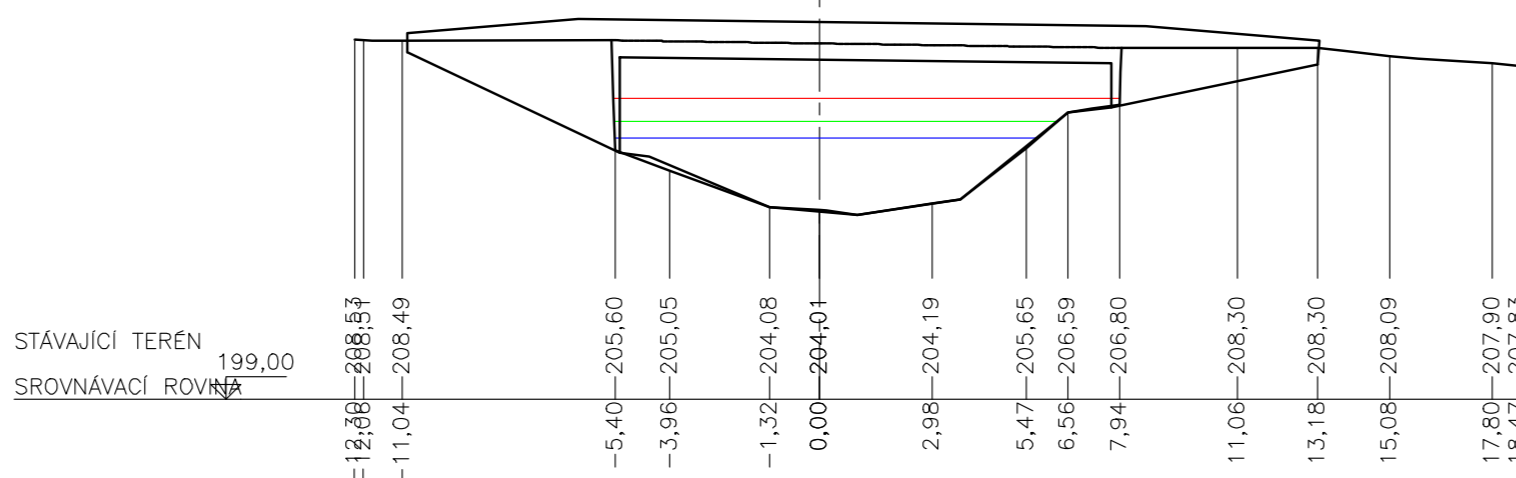

P 121 km 5,661 93

Q<sub>10</sub> = 69,9 m<sup>3</sup>/s, 204,92 m n.m.  
Q<sub>5</sub> = 45,3 m<sup>3</sup>/s, 204,98 m n.m.  
Q<sub>1</sub> = 28,2 m<sup>3</sup>/s, 204,98 m n.m.

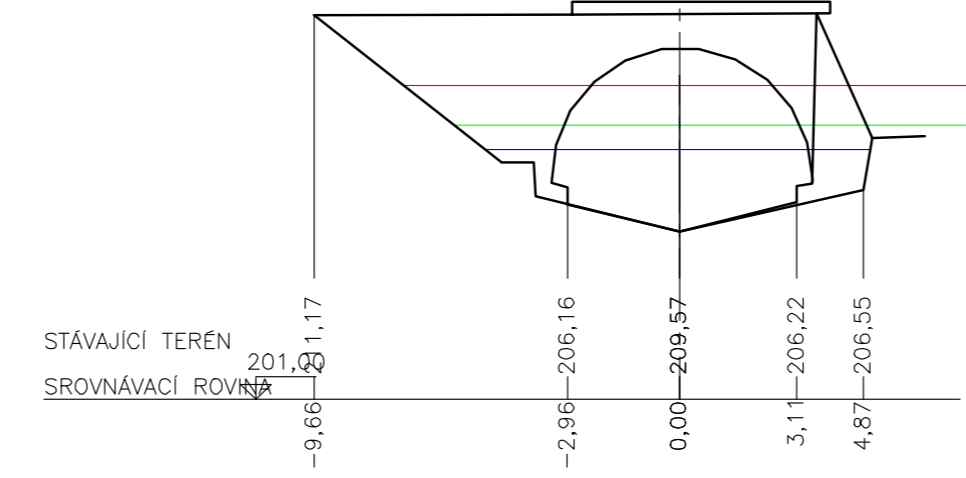

P 122 km 5,746 18

Q<sub>10</sub> = 69,9 m<sup>3</sup>/s, 204,92 m n.m.  
Q<sub>5</sub> = 45,3 m<sup>3</sup>/s, 204,98 m n.m.  
Q<sub>1</sub> = 28,2 m<sup>3</sup>/s, 204,98 m n.m.

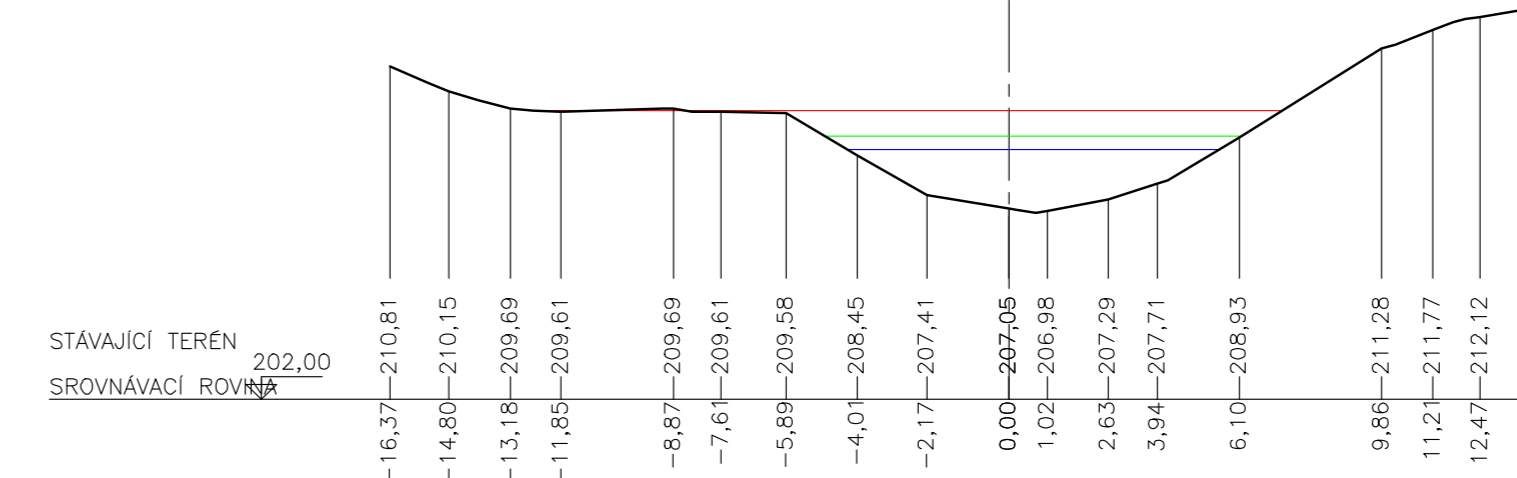

P 99 km 4,581 06

Q<sub>10</sub> = 69,9 m<sup>3</sup>/s, 204,92 m n.m.  
Q<sub>5</sub> = 45,3 m<sup>3</sup>/s, 204,98 m n.m.  
Q<sub>1</sub> = 28,2 m<sup>3</sup>/s, 204,98 m n.m.

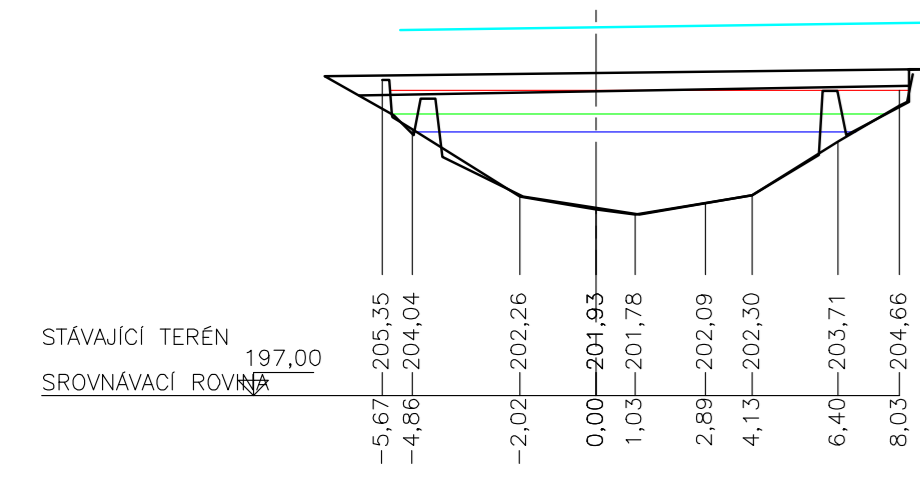

P 106 km 4,938 46

Q<sub>10</sub> = 69,9 m<sup>3</sup>/s, 204,92 m n.m.  
Q<sub>5</sub> = 45,3 m<sup>3</sup>/s, 204,98 m n.m.  
Q<sub>1</sub> = 28,2 m<sup>3</sup>/s, 204,98 m n.m.

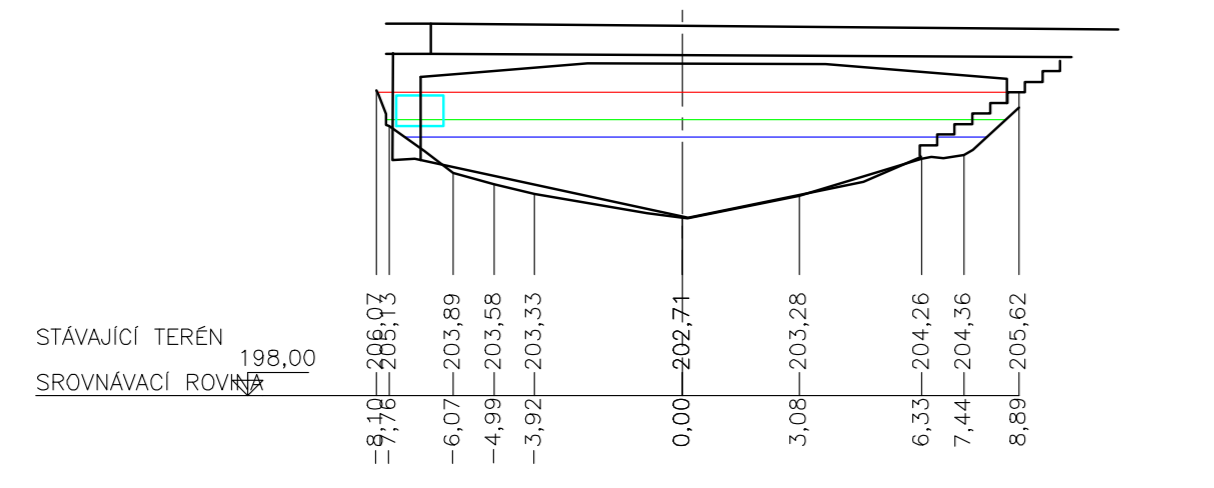

P 115 km 5,311 42

Q<sub>10</sub> = 69,9 m<sup>3</sup>/s, 204,92 m n.m.  
Q<sub>5</sub> = 45,3 m<sup>3</sup>/s, 204,98 m n.m.  
Q<sub>1</sub> = 28,2 m<sup>3</sup>/s, 204,98 m n.m.

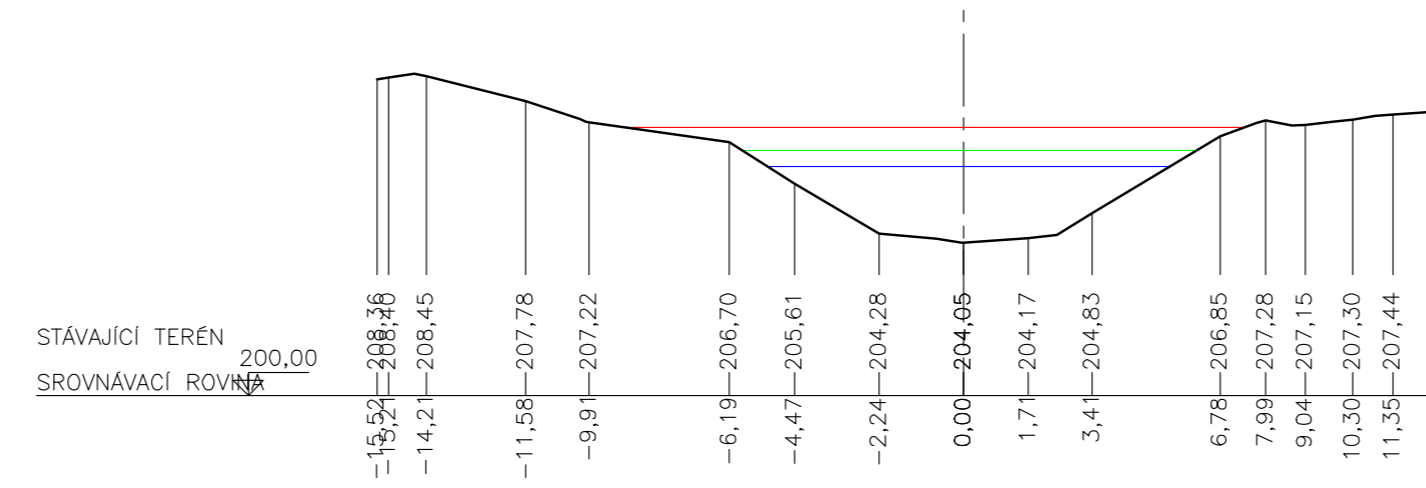

P 123 km 5,858 87

Q<sub>10</sub> = 69,9 m<sup>3</sup>/s, 204,92 m n.m.  
Q<sub>5</sub> = 45,3 m<sup>3</sup>/s, 204,98 m n.m.  
Q<sub>1</sub> = 28,2 m<sup>3</sup>/s, 204,98 m n.m.

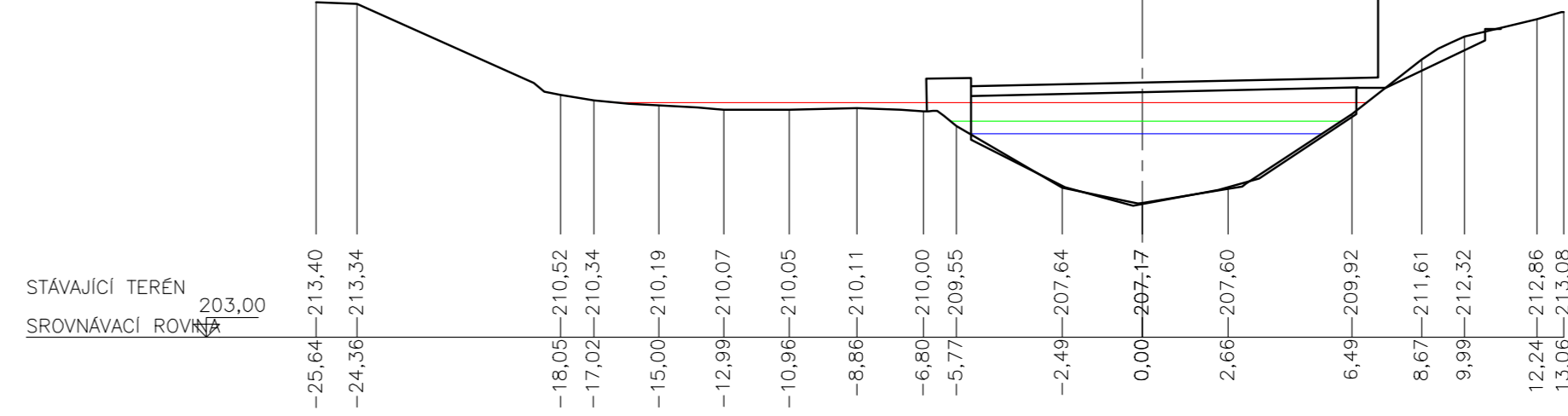

P 100 km 4,641 07

Q<sub>10</sub> = 69,9 m<sup>3</sup>/s, 204,92 m n.m.  
Q<sub>5</sub> = 45,3 m<sup>3</sup>/s, 204,98 m n.m.  
Q<sub>1</sub> = 28,2 m<sup>3</sup>/s, 204,98 m n.m.

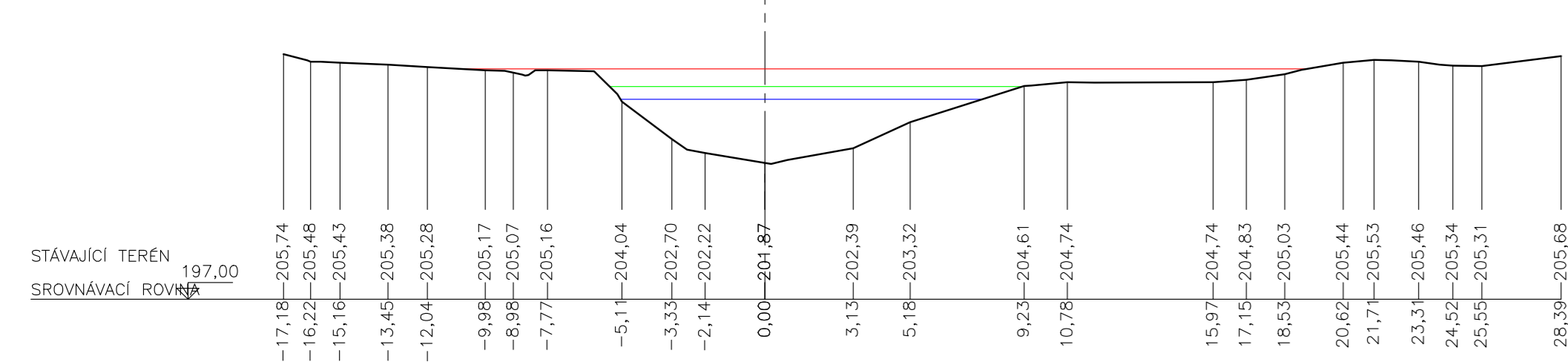

P 107 km 4,956 01

Q<sub>10</sub> = 69,9 m<sup>3</sup>/s, 204,92 m n.m.  
Q<sub>5</sub> = 45,3 m<sup>3</sup>/s, 204,98 m n.m.  
Q<sub>1</sub> = 28,2 m<sup>3</sup>/s, 204,98 m n.m.

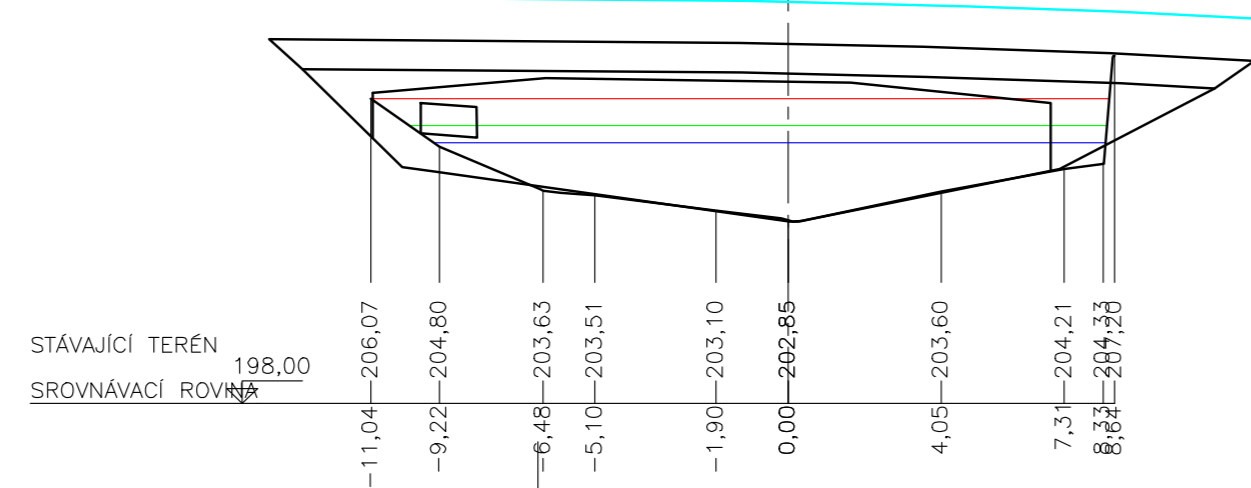

P 117 km 5,401 89

Q<sub>10</sub> = 69,9 m<sup>3</sup>/s, 204,92 m n.m.  
Q<sub>5</sub> = 45,3 m<sup>3</sup>/s, 204,98 m n.m.  
Q<sub>1</sub> = 28,2 m<sup>3</sup>/s, 204,98 m n.m.

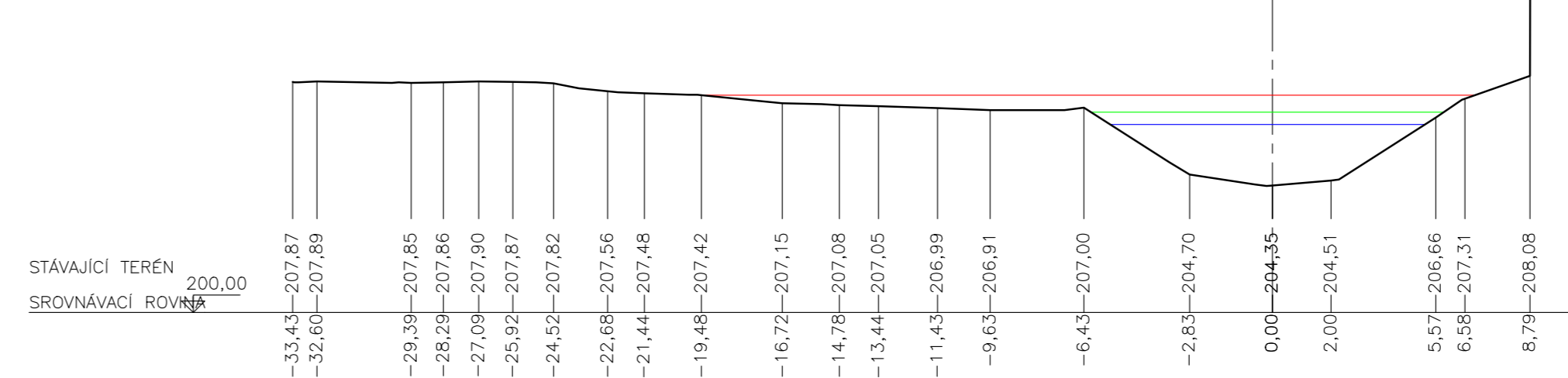

P 101 km 4,685 94

Q<sub>10</sub> = 69,9 m<sup>3</sup>/s, 204,92 m n.m.  
Q<sub>5</sub> = 45,3 m<sup>3</sup>/s, 204,98 m n.m.  
Q<sub>1</sub> = 28,2 m<sup>3</sup>/s, 204,98 m n.m.

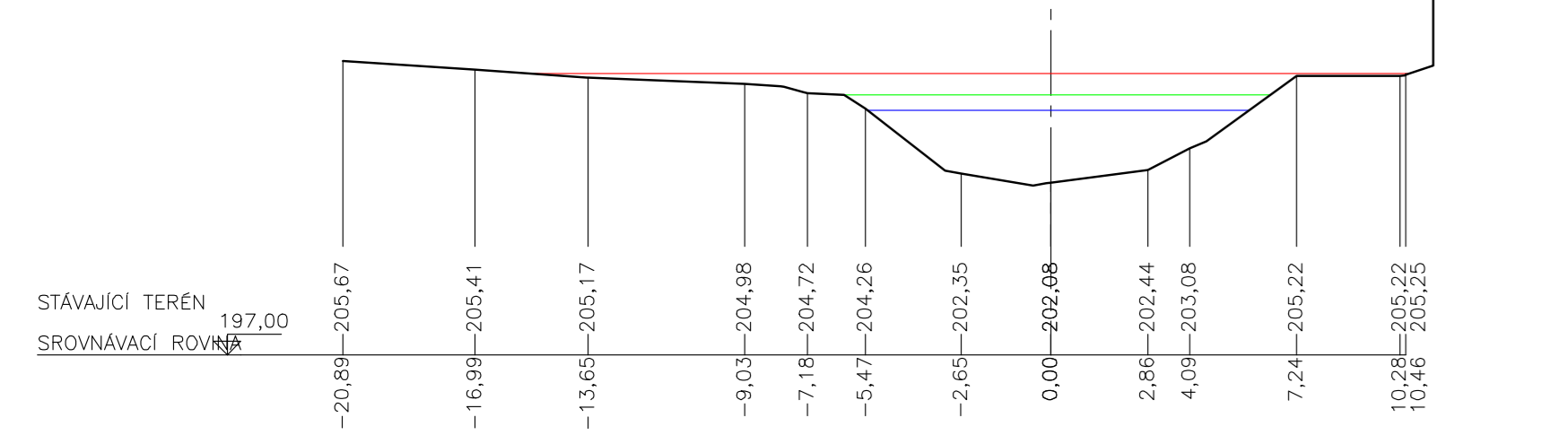

P 108 km 5,001 50

Q<sub>10</sub> = 69,9 m<sup>3</sup>/s, 204,92 m n.m.  
Q<sub>5</sub> = 45,3 m<sup>3</sup>/s, 204,98 m n.m.  
Q<sub>1</sub> = 28,2 m<sup>3</sup>/s, 204,98 m n.m.

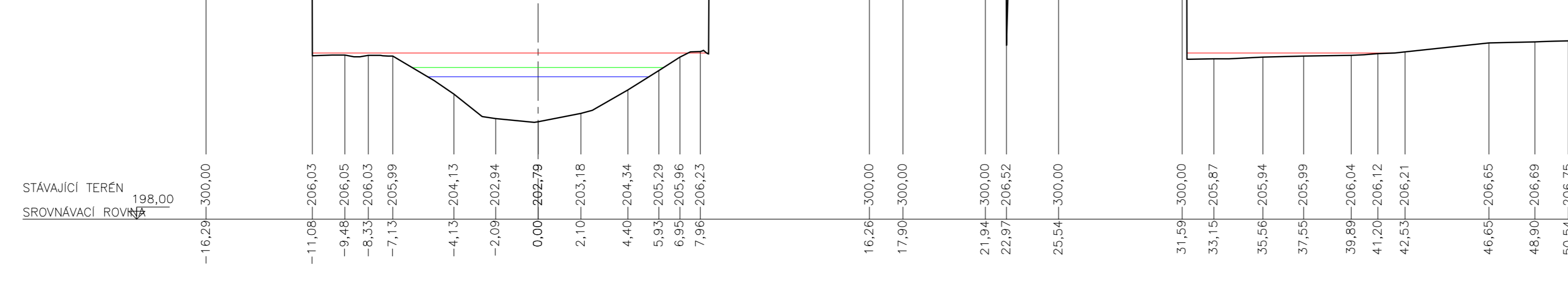

P 118 km 5,475 98

Q<sub>10</sub> = 69,9 m<sup>3</sup>/s, 204,92 m n.m.  
Q<sub>5</sub> = 45,3 m<sup>3</sup>/s, 204,98 m n.m.  
Q<sub>1</sub> = 28,2 m<sup>3</sup>/s, 204,98 m n.m.

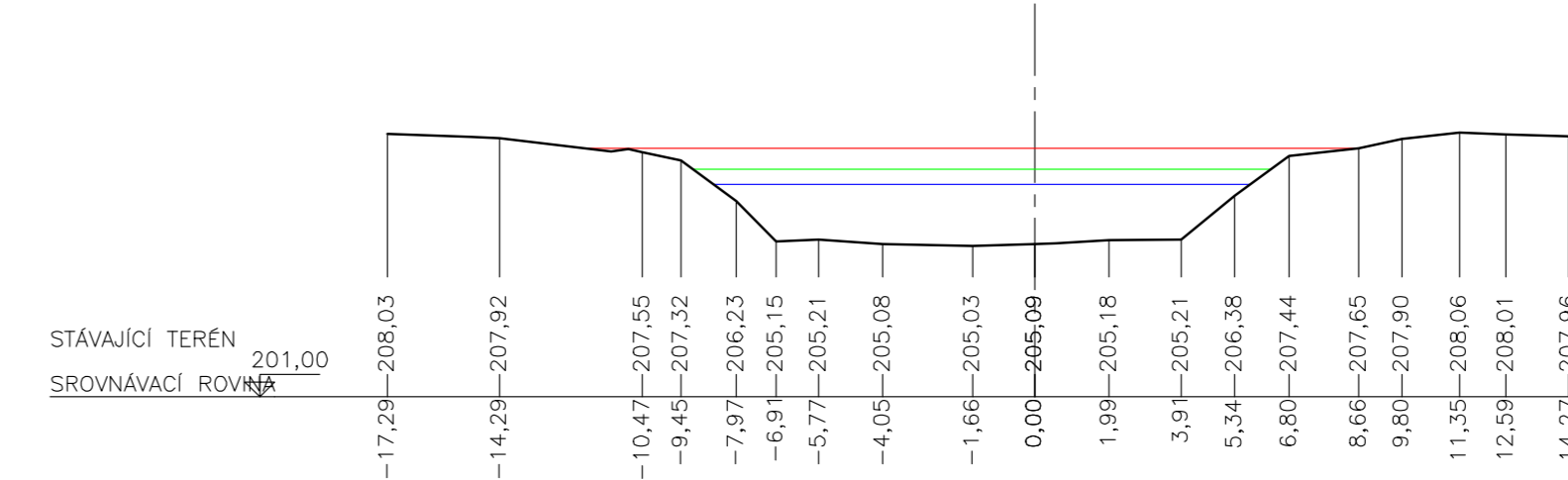

P 102 km 4,710 45

Q<sub>10</sub> = 69,9 m<sup>3</sup>/s, 204,92 m n.m.  
Q<sub>5</sub> = 45,3 m<sup>3</sup>/s, 204,98 m n.m.  
Q<sub>1</sub> = 28,2 m<sup>3</sup>/s, 204,98 m n.m.

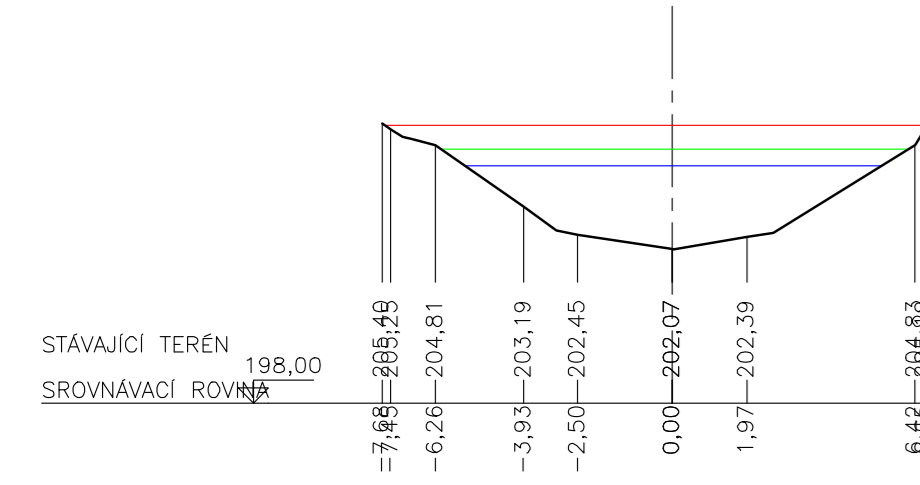

P 109 km 5,061 15

Q<sub>10</sub> = 69,9 m<sup>3</sup>/s, 204,92 m n.m.  
Q<sub>5</sub> = 45,3 m<sup>3</sup>/s, 204,98 m n.m.  
Q<sub>1</sub> = 28,2 m<sup>3</sup>/s, 204,98 m n.m.

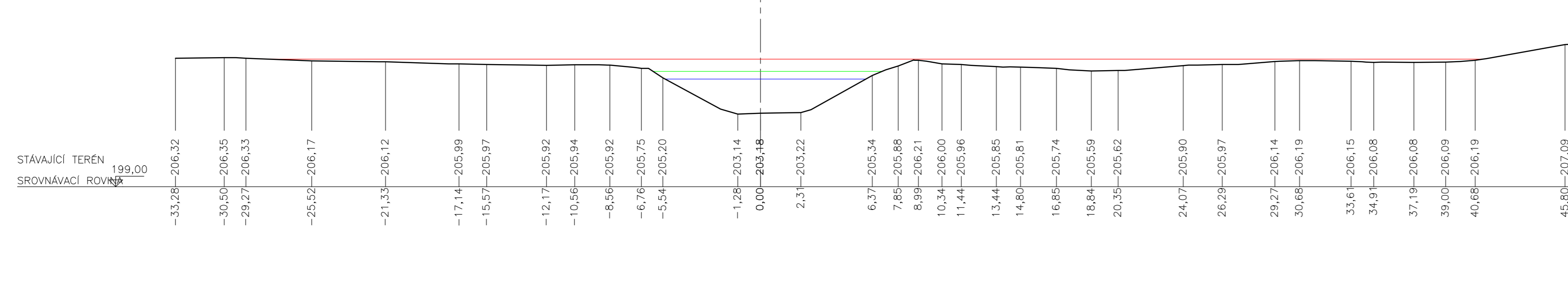

P 119 km 5,485 46

Q<sub>10</sub> = 69,9 m<sup>3</sup>/s, 204,92 m n.m.  
Q<sub>5</sub> = 45,3 m<sup>3</sup>/s, 204,98 m n.m.  
Q<sub>1</sub> = 28,2 m<sup>3</sup>/s, 204,98 m n.m.

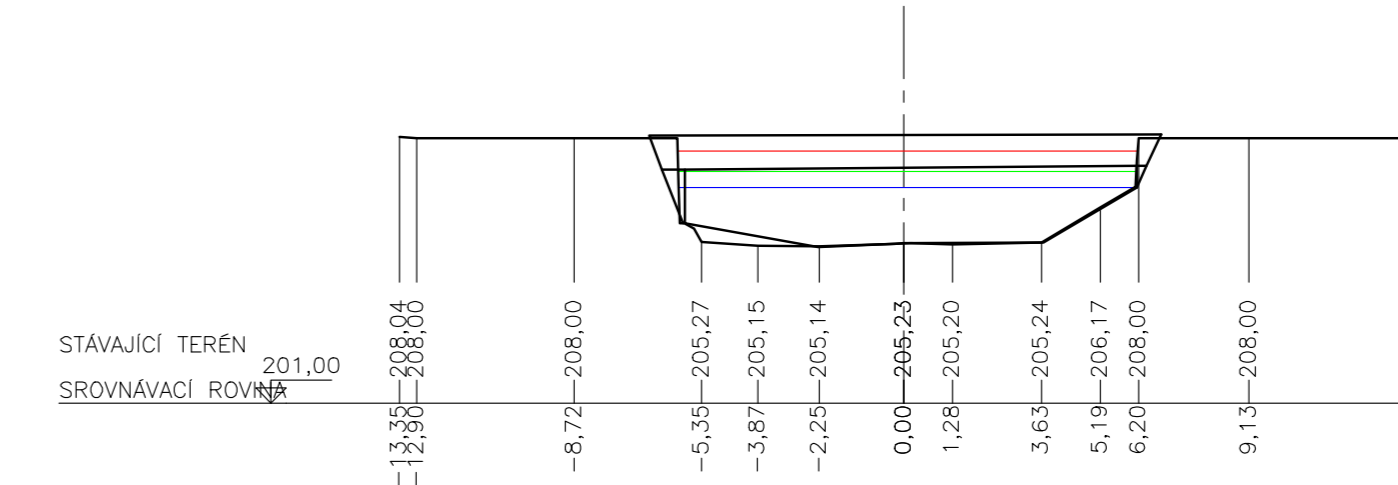

P 103 km 4,790 97

Q<sub>10</sub> = 69,9 m<sup>3</sup>/s, 204,92 m n.m.  
Q<sub>5</sub> = 45,3 m<sup>3</sup>/s, 204,98 m n.m.  
Q<sub>1</sub> = 28,2 m<sup>3</sup>/s, 204,98 m n.m.

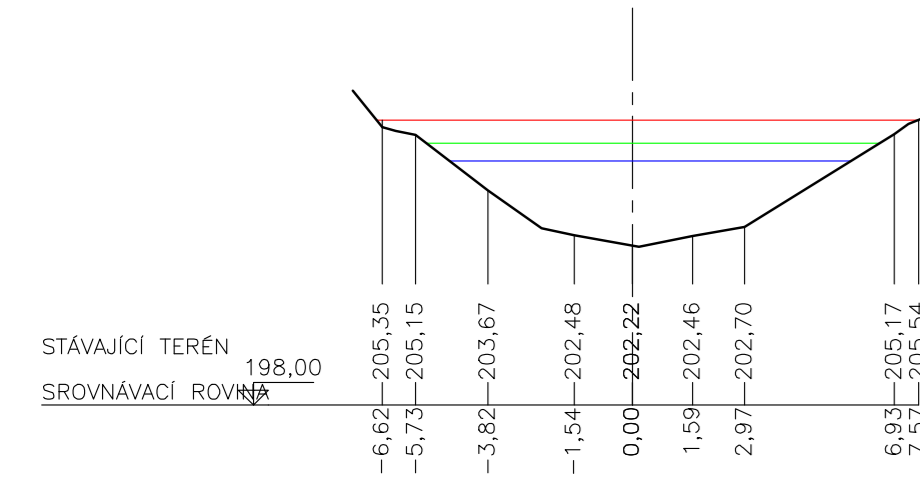

P 110 km 5,089 89

Q<sub>10</sub> = 69,9 m<sup>3</sup>/s, 204,92 m n.m.  
Q<sub>5</sub> = 45,3 m<sup>3</sup>/s, 204,98 m n.m.  
Q<sub>1</sub> = 28,2 m<sup>3</sup>/s, 204,98 m n.m.

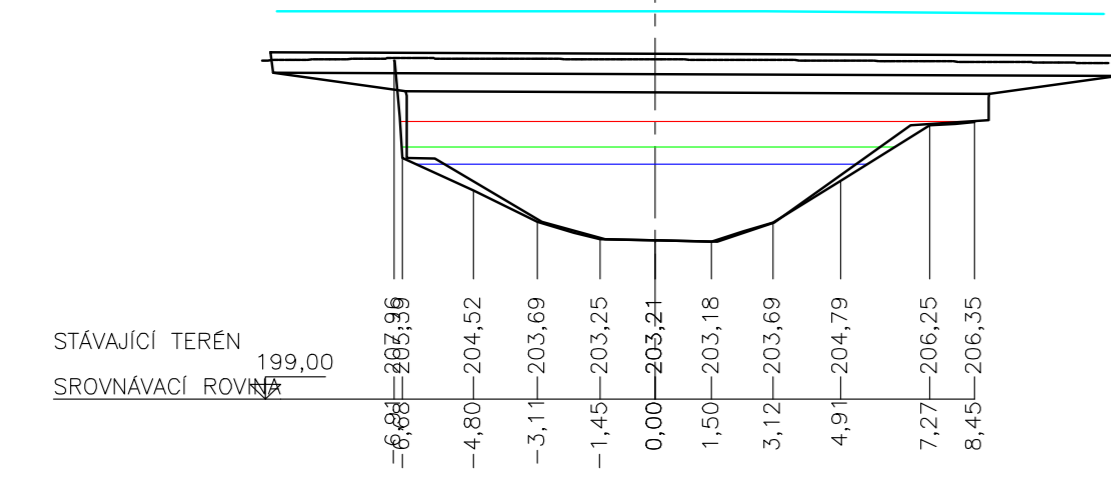

P 111 km 5,119 59

Q<sub>10</sub> = 69,9 m<sup>3</sup>/s, 204,92 m n.m.  
Q<sub>5</sub> = 45,3 m<sup>3</sup>/s, 204,98 m n.m.  
Q<sub>1</sub> = 28,2 m<sup>3</sup>/s, 204,98 m n.m.

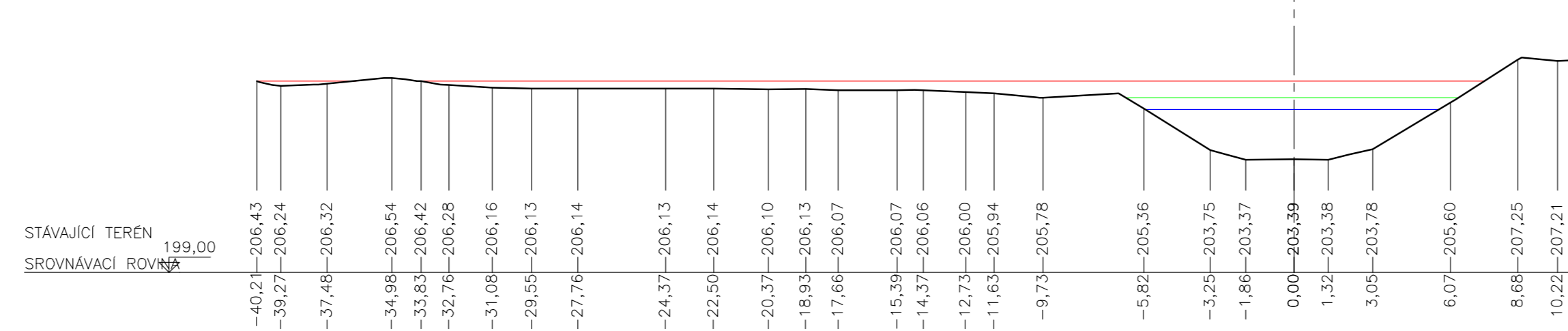

P 120 km 5,506 33

Q<sub>10</sub> = 69,9 m<sup>3</sup>/s, 204,92 m n.m.  
Q<sub>5</sub> = 45,3 m<sup>3</sup>/s, 204,98 m n.m.  
Q<sub>1</sub> = 28,2 m<sup>3</sup>/s, 204,98 m n.m.

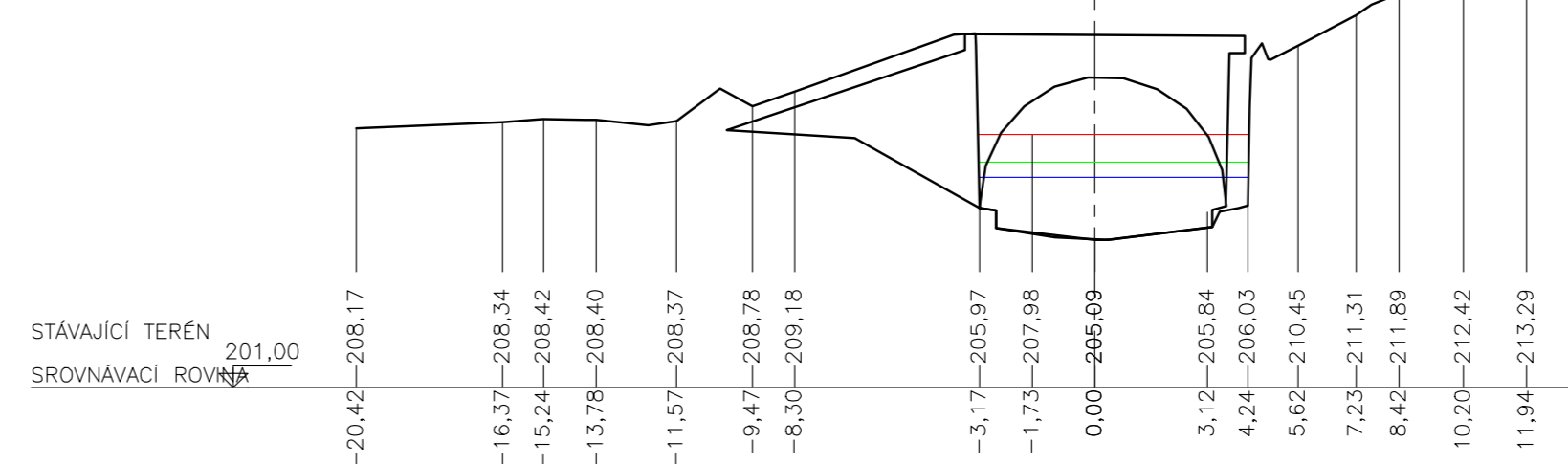

INVESTOR	HLAVNÍ MĚSTO PRAHA ZASTUPENÉ: MHMP-OCP JUNGMANNOVA 35, PRAHA 1	KONTROLOVAL Doc. Ing. Havlík, CSc.	SOUŘADNÝ SYSTÉM VÝŠKOVÝ SYSTÉM	S - ÚTSK Bpv
ZPRACOVATEL	TEL. 605 159 536 ČVÚT FSV Thákurova 7, Praha 6	VYPRACOVAL ING. HYBÁŠEK	DATUM	3.2022
AKCE	Bořič Dokumentace záplavových území	KRAJ (MĚSTSKÁ ČÁST) PRAHA	FORMÁT	A4
PRÍLOHA	Údolní profily 97 - 120	ČÍSLO PROJEKTU	2105	MĚŘÍTKO
		REVIZE		MĚŘÍTKO
		DATUM REV.		PRÍLOHA
				3.3